

Article number: 04H081900500200

Description: Stabilus IndustryLine gas spring size 08/19
200N length 145mm, stroke 50mm Type 04H0819200

Measures

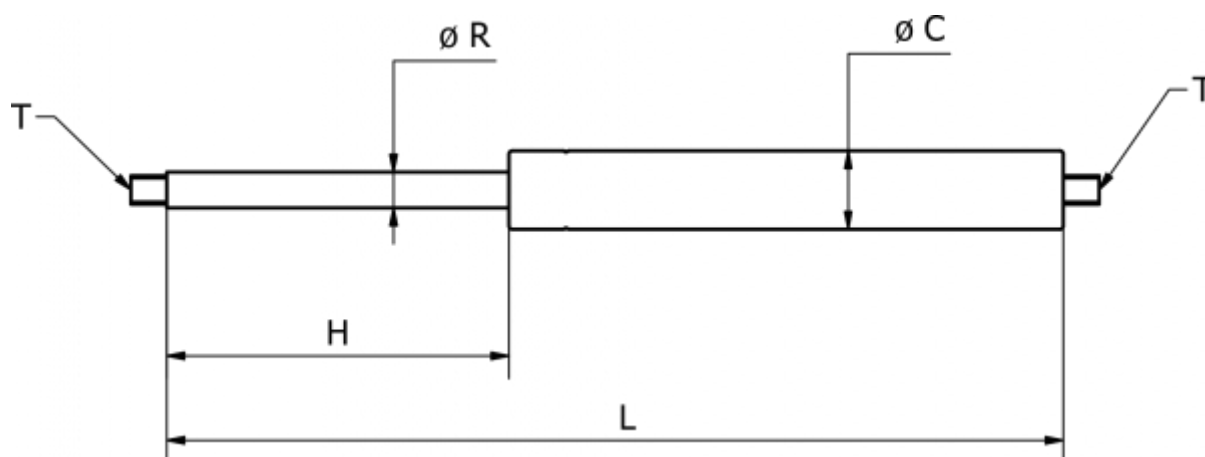

C = 19

H = 50

L = 145

R = 8

T = M8 x 10